

NATIONAL CAR WASH PARTS & EQUIPMENT

SS SIGNATURE SERIES
CAR WASH PRODUCTS



CK Enterprises Inc.

CK Enterprises, Inc. Tel: (816) 524-1304
1992 NW HWY 50 Fax: (816) 524-3260
Lone Jack, MO 64070 Web: ckcarcare.com

ALL ROADS LEAD TO CLEAN.

DIVISIONS OF C K ENTERPRISES, INC.



C K Enterprises, Inc. Tel: (816) 524-1304
1992 NW HWY 50 Fax: (816) 524-3260
Lone Jack, MO 64070 Web: www.ckcarcare.com



 At C K, we believe Clean is a destination.

Every product we make and every person we employ understands that no matter the mess, we've got a product that can clean it. For us, Clean is the place where everyone wants to be.

Luckily our founder, Charlie Kunkel III, discovered how to get there over 40 years ago. And he's been guiding others to the promised land ever since.

Whether it's through private labeling our products, offering quality car wash soaps and detergents, cleaning food plants, or printing labels, signs, and marketing materials, Charlie has always tried to do things one way: **RIGHT.**

From the beginning, he's put his people first, believing that the way you treat people is the only true thing that matters.

That philosophy turned C K Enterprises Inc. from one man and a mixing tank to a 133,000 square foot campus, employing over 350 people across the United States, blending around 100,000 lbs of chemicals every week, and printing over 2,000,000 labels per year.

COME TO CLEAN WITH US.

There's plenty of room (and it always smells great).



C K Enterprises Inc.

TABLE OF CONTENTS

NATIONAL CAR WASH PARTS

PAGE 6 - REACTION ARCHES



PAGE 25 - REACTION LEDs



PAGE 25 - REACTION PROJECTOR



PAGE 26 - REACTION FOAMERS



PAGE 40



PAGE 42

TITRATION EQUIPMENT



PAGE 44

TIPS



PAGE 47

INJECTORS



PAGE 59

MISC. EQUIPMENT





CK Enterprises Inc.

HOW TO ORDER...



TO PURCHASE PARTS PLEASE CALL:



DJ Baltuska

Office: (816) 890-8995

Email: djb@ckeinc.com

THE CAR WASH EXPERIENCE THEY WON'T FORGET.



These illuminated, powder-coated arches are a great way to give your wash that added boost it needs. With six different shapes, three different design styles, and the ability to totally customize, these arches could quickly become the focal point for your wash.



Scan me to watch the video!



STEP 1:

CLEAN



STEP 2:

PREP



STEP 3:

SHINE

INFERNO
EXTREME SHINE

SHINE

WITH CARNAUBA

SIGNATURE SERIES

REACT
ARCHES



4

STEP 4:

FOAM
FLUSH

5

STEP 5:

CERAMIC

6

STEP 6:

REPEL

7

STEP 7:

SEAL

REACTION

ARCHES 

REACTION

FOAMERS 

We offer multiple foamer bars custom made to fit these one-of-a-kind arches.

PAGE 26

REACTION

LEDs 

Pulse, glow, fade—you choose how these LED light bars react. Choose from 5 different light colors. You can even do all 5 colors at once to create a rainbow effect. The possibilities are endless.

PAGE 25

With so many options of LEDs, foamers, and even a custom projector shining down your logo onto cars, you'll have a blast choosing how yours reacts.



REACTION
PROJECTOR 

Want to shine your logo onto your customer's vehicle as they go through your wash? Well now you can with the Reaction Projector.

PAGE 25



1. CHOOSE YOUR SHAPE

RA1

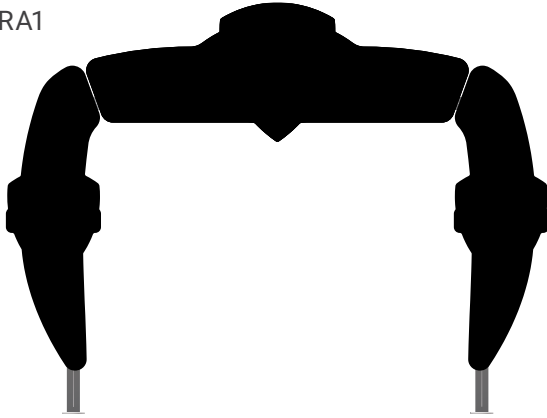

RA2

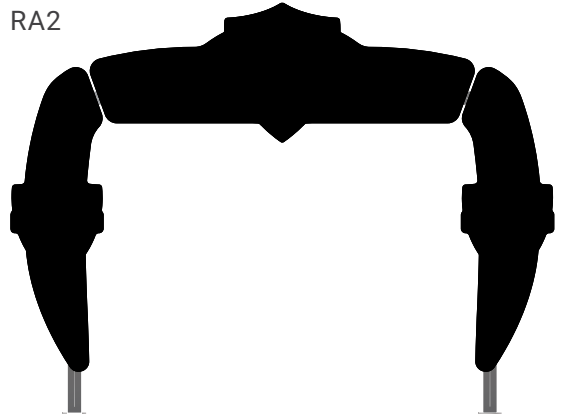

RA3

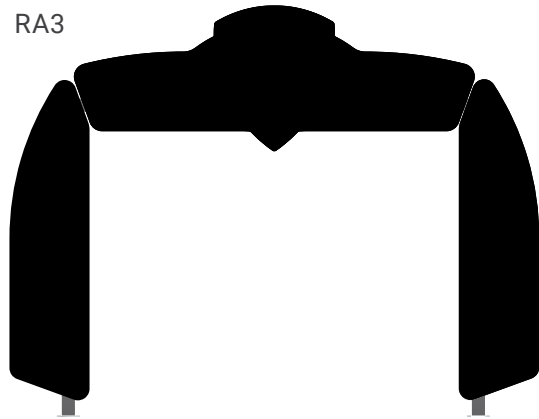

RA4



RA5

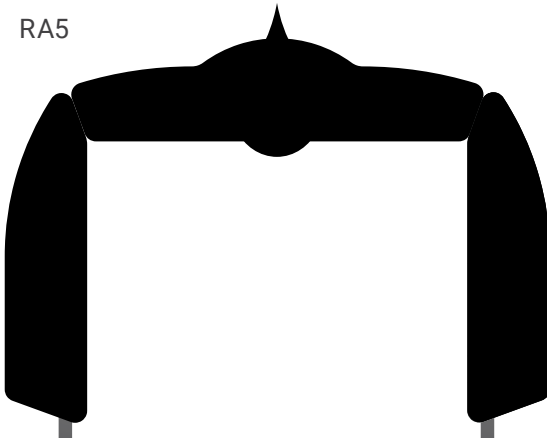

RA6

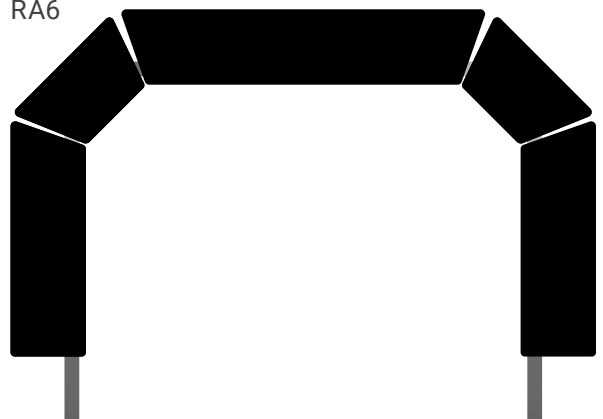

2. CHOOSE YOUR DESIGN



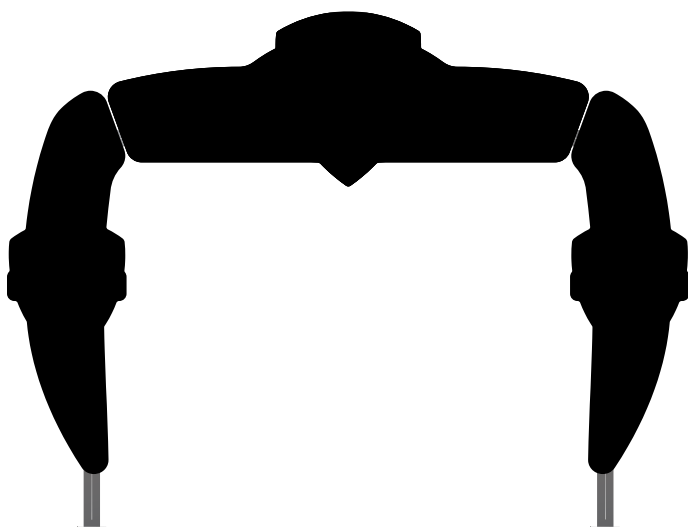

REACTION ARCH #1

The most popular arch we offer, Reaction Arch #1 offers you a completely unique, stylish shape you can only get from us. All of our arches come with black aluminum frames with options to add powder coating and back lights. A multitude of options gives you the versatility to custom design* the entire arch, from the graphics to the foamers to the led lights. If you'd rather go with how you see them in this catalog, no problem. You can choose a design from one of our three templates and package setups. Sizes vary by arch shape. Call for exact measurements.

Part #	Description
RA1	No Powder Coating or Flasher

*For all other arch options like powder coating, back-lighting, custom graphics, and more—please see page 23.

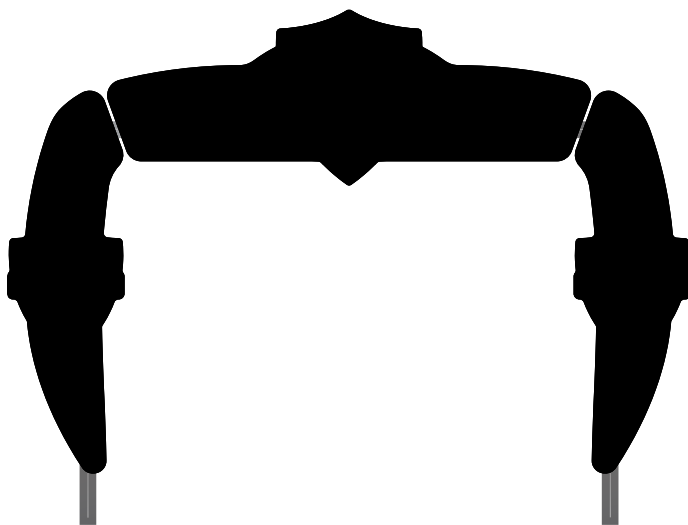

REACTION ARCH #2

The second most popular arch we offer, Reaction Arch #2 offers you a completely unique, stylish shape you can only get from us. All of our arches come with black aluminum frames with options to add powder coating and back lights. A multitude of options gives you the versatility to custom design* the entire arch, from the graphics to the foamers to the led lights. If you'd rather go with how you see them in this catalog, no problem. You can choose a design from one of our three templates and package setups. Sizes vary by arch shape. Call for exact measurements.

Part #	Description
RA2	No Powder Coating or Flasher

*For all other arch options like powder coating, back-lighting, custom graphics, and more—please see page 23.

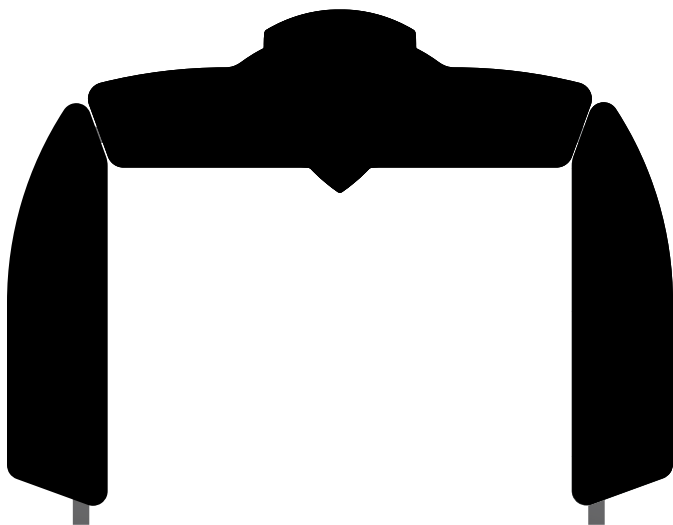

REACTION ARCH #3

Reaction Arch #3 offers you a completely unique, stylish shape you can only get from us. All of our arches come with black aluminum frames with options to add powder coating and back lights. A multitude of options gives you the versatility to custom design* the entire arch, from the graphics to the foamers to the led lights. If you'd rather go with how you see them in this catalog, no problem. You can choose a design from one of our three templates and package setups. Sizes vary by arch shape. Call for exact measurements.

Part #	Description
RA3	No Powder Coating or Flasher

*For all other arch options like powder coating, back-lighting, custom graphics, and more—please see page 23.



REACTION ARCH #4

All of our arches come with black aluminum frames with options to add powder coating and back lights. A multitude of options gives you the versatility to custom design* the entire arch, from the graphics to the foamers to the led lights. If you'd rather go with how you see them in this catalog, no problem. You can choose a design from one of our three templates and package setups. Sizes vary by arch shape. Call for exact measurements.

Part #	Description
RA4	No Powder Coating or Flasher

*For all other arch options like powder coating, back-lighting, custom graphics, and more—please see page 23.

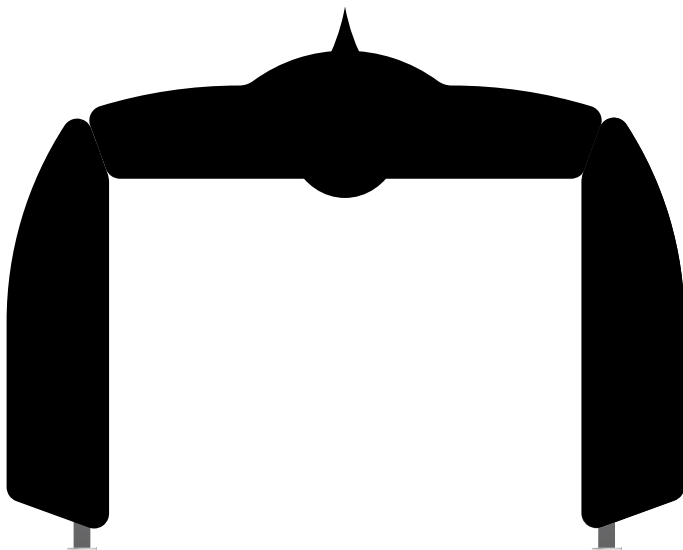

REACTION ARCH #5

Reaction Arch #5 offers you a completely unique, stylish shape you can only get from us. All of our arches come with black aluminum frames with options to add powder coating and back lights. A multitude of options gives you the versatility to custom design* the entire arch, from the graphics to the foamers to the led lights. If you'd rather go with how you see them in this catalog, no problem. You can choose a design from one of our three templates and package setups. Sizes vary by arch shape. Call for exact measurements.

Part #	Description
RA5	No Powder Coating or Flasher

*For all other arch options like powder coating, back-lighting, custom graphics, and more—please see page 23.

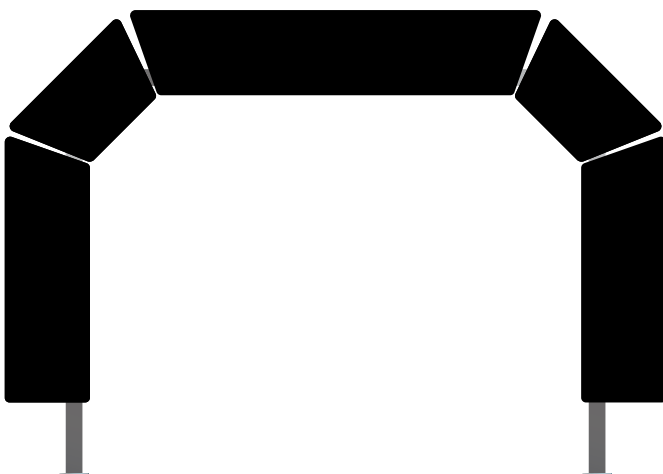

REACTION ARCH #6

All of our arches come with black aluminum frames with options to add powder coating and back lights. A multitude of options gives you the versatility to custom design* the entire arch, from the graphics to the foamers to the led lights. If you'd rather go with how you see them in this catalog, no problem. You can choose a design from one of our three templates and package setups. Sizes vary by arch shape. Call for exact measurements.

Part #	Description
RA6	No Powder Coating or Flasher

*For all other arch options like powder coating, back-lighting, custom graphics, and more—please see page 23.



CLEAN ARCH DESIGN #1

A multitude of options gives you the versatility to custom design* the entire arch, from the graphics to the foamers to led lights. If you'd rather go with how you see them in this catalog, no problem. You can choose a design from one of our three templates and package setups.

Part #	RA1-C-A
*	Multiple Customizations Available. Please see page 23



CLEAN ARCH DESIGN #2

A multitude of options gives you the versatility to custom design* the entire arch, from the graphics to the foamers to led lights. If you'd rather go with how you see them in this catalog, no problem. You can choose a design from one of our three templates and package setups.

Part #	RA1-C-B
*	*Multiple Customizations Available. Please see page 23



CLEAN ARCH DESIGN #3

A multitude of options gives you the versatility to custom design* the entire arch, from the graphics to the foamers to led lights. If you'd rather go with how you see them in this catalog, no problem. You can choose a design from one of our three templates and package setups.

Part #	RA1-C-C
*	Multiple Customizations Available. Please see page 23



PREP ARCH DESIGN #1

A multitude of options gives you the versatility to custom design* the entire arch, from the graphics to the foamers to led lights. If you'd rather go with how you see them in this catalog, no problem. You can choose a design from one of our three templates and package setups.

Part #	RA1-P-A
*	Multiple Customizations Available. Please see page 23



PREP ARCH DESIGN #2

A multitude of options gives you the versatility to custom design* the entire arch, from the graphics to the foamers to led lights. If you'd rather go with how you see them in this catalog, no problem. You can choose a design from one of our three templates and package setups.

Part #	RA1-P-B
*	Multiple Customizations Available. Please see page 23



PREP ARCH DESIGN #3

A multitude of options gives you the versatility to custom design* the entire arch, from the graphics to the foamers to led lights. If you'd rather go with how you see them in this catalog, no problem. You can choose a design from one of our three templates and package setups.

Part #	RA1-P-C
*	Multiple Customizations Available. Please see page 23



SHINE ARCH DESIGN #1

A multitude of options gives you the versatility to custom design* the entire arch, from the graphics to the foamers to led lights. If you'd rather go with how you see them in this catalog, no problem. You can choose a design from one of our three templates and package setups.

Part #	RA1-S-A
*	Multiple Customizations Available. Please see page 23



SHINE ARCH DESIGN #2

A multitude of options gives you the versatility to custom design* the entire arch, from the graphics to the foamers to led lights. If you'd rather go with how you see them in this catalog, no problem. You can choose a design from one of our three templates and package setups.

Part #	RA1-S-B
*	Multiple Customizations Available. Please see page 23



SHINE ARCH DESIGN #3

A multitude of options gives you the versatility to custom design* the entire arch, from the graphics to the foamers to led lights. If you'd rather go with how you see them in this catalog, no problem. You can choose a design from one of our three templates and package setups.

Part #	RA1-S-C
*	Multiple Customizations Available. Please see page 23



FOAM FLUSH ARCH DESIGN #1

A multitude of options gives you the versatility to custom design* the entire arch, from the graphics to the foamers to led lights. If you'd rather go with how you see them in this catalog, no problem. You can choose a design from one of our three templates and package setups.

Part #	RA1-FF-A
*	Multiple Customizations Available. Please see page 23



FOAM FLUSH ARCH DESIGN #2

A multitude of options gives you the versatility to custom design* the entire arch, from the graphics to the foamers to led lights. If you'd rather go with how you see them in this catalog, no problem. You can choose a design from one of our three templates and package setups.

Part #	RA1-FF-B
*	Multiple Customizations Available. Please see page 23



FOAM FLUSH ARCH DESIGN #3

A multitude of options gives you the versatility to custom design* the entire arch, from the graphics to the foamers to led lights. If you'd rather go with how you see them in this catalog, no problem. You can choose a design from one of our three templates and package setups.

Part #	RA1-FF-C
*	Multiple Customizations Available. Please see page 23



CERAMIC ARCH DESIGN #1

A multitude of options gives you the versatility to custom design* the entire arch, from the graphics to the foamers to led lights. If you'd rather go with how you see them in this catalog, no problem. You can choose a design from one of our three templates and package setups.

Part #	RA2-TS-A
*	Multiple Customizations Available. Please see page 23



CERAMIC ARCH DESIGN #2

A multitude of options gives you the versatility to custom design* the entire arch, from the graphics to the foamers to led lights. If you'd rather go with how you see them in this catalog, no problem. You can choose a design from one of our three templates and package setups.

Part #	RA2-TS-B
*	Multiple Customizations Available. Please see page 23



CERAMIC ARCH DESIGN #3

A multitude of options gives you the versatility to custom design* the entire arch, from the graphics to the foamers to led lights. If you'd rather go with how you see them in this catalog, no problem. You can choose a design from one of our three templates and package setups.

Part #	RA1-TS-C
*	Multiple Customizations Available. Please see page 23



REPEL ARCH DESIGN #1

A multitude of options gives you the versatility to custom design* the entire arch, from the graphics to the foamers to led lights. If you'd rather go with how you see them in this catalog, no problem. You can choose a design from one of our three templates and package setups.

Part #	RA1-R-A
*	Multiple Customizations Available. Please see page 23



REPEL ARCH DESIGN #2

A multitude of options gives you the versatility to custom design* the entire arch, from the graphics to the foamers to led lights. If you'd rather go with how you see them in this catalog, no problem. You can choose a design from one of our three templates and package setups.

Part #	RA1-R-B
*	Multiple Customizations Available. Please see page 23



REPEL ARCH DESIGN #3

A multitude of options gives you the versatility to custom design* the entire arch, from the graphics to the foamers to led lights. If you'd rather go with how you see them in this catalog, no problem. You can choose a design from one of our three templates and package setups.

Part #	RA1-R-C
*	Multiple Customizations Available. Please see page 23



SEAL ARCH DESIGN #1

A multitude of options gives you the versatility to custom design* the entire arch, from the graphics to the foamers to led lights. If you'd rather go with how you see them in this catalog, no problem. You can choose a design from one of our three templates and package setups.

Part #	RA2-SEAL-A
*	Multiple Customizations Available. Please see page 23



SEAL ARCH DESIGN #2

A multitude of options gives you the versatility to custom design* the entire arch, from the graphics to the foamers to led lights. If you'd rather go with how you see them in this catalog, no problem. You can choose a design from one of our three templates and package setups.

Part #	RA2-SEAL-B
*	Multiple Customizations Available. Please see page 23



SEAL ARCH DESIGN #3

A multitude of options gives you the versatility to custom design* the entire arch, from the graphics to the foamers to led lights. If you'd rather go with how you see them in this catalog, no problem. You can choose a design from one of our three templates and package setups.

Part #	RA1-SEAL-C
*	Multiple Customizations Available. Please see page 23



ENTRANCE ARCH DESIGN #1

A multitude of options gives you the versatility to custom design* the entire arch, from the graphics to the foamers to led lights. If you'd rather go with how you see them in this catalog, no problem. You can choose a design from one of our three templates and package setups.

Part #	RA3-E-A
*	Multiple Customizations Available. Please see page 23



ENTRANCE ARCH DESIGN #2

A multitude of options gives you the versatility to custom design* the entire arch, from the graphics to the foamers to led lights. If you'd rather go with how you see them in this catalog, no problem. You can choose a design from one of our three templates and package setups.

Part #	RA3-E-B
*	Multiple Customizations Available. Please see page 23



LIGHT PUCKS ENTRANCE ARCH

This arch has the option of having both the left and right section light up, letting your customers know what they need to do when entering your wash and/or which wash package they have purchased. A multitude of options gives you the versatility to custom design* the entire arch, from the graphics to the foamers to led lights. If you'd rather go with how you see them in this catalog, no problem. You can choose a design from one of our three templates and package setups.

Part #	RA6-PUCKS
*	Multiple Customizations Available. Please see page 23

REACTION

MENU SIGNS

Finding a car wash with a simple, yet effective menu is never an easy task. That's why we offer a Classic Menu Sign that reflects the quality of wash you offer. Choose from 3 different sizes and customize your sign for a more branded look and feel.

Dimensions:	36" x 60" / 36" x 72" / 36" x 96"
Material:	Aluminum cabinet with Lexan OR MaxMetal face
Mounting:	Frame Sold Separately. Please inquire during design
Power:	24 volt power supply included
Trim Options:	Blue, red, yellow, green, black and white

Product #	Description
RS-3660-LEX	36" x 60" Classic Menu Sign - Lexan
RS-3660-MAX	36" x 60" Classic Menu Sign - MaxMetal
RS-3672-LEX	36" x 72" Classic Menu Sign - Lexan
RS-3672-MAX	36" x 72" Classic Menu Sign - MaxMetal
RS-3696-LEX	36" x 96" Classic Menu Sign - Lexan
RS-3696-MAX	36" x 96" Classic Menu Sign - MaxMetal



STAND & FRAME SOLD SEPARATELY





REACTION ARCH ADDITIONAL OPTIONS

Part #	Description
RA1	Reaction Arch Shape 1 - No Powder Coating or Flasher
RA2	Reaction Arch Shape 2 - No Powder Coating or Flasher
RA3	Reaction Arch Shape 3 - No Powder Coating or Flasher
RA4	Reaction Arch Shape 4 - No Powder Coating or Flasher
RA5	Reaction Arch Shape 5 - No Powder Coating or Flasher
RA6	Reaction Arch Shape 6 - No Powder Coating or Flasher
RA-CUSTOM-GR	Reaction Arch Custom Graphics
RA-CUSTOM-SH	Reaction Arch Custom Shape
RA-155	Reaction Arch Back Light Delete
RA-ENTRANCE	Reaction Entrance Arch
RA-BARE-ARCH	Basic Product Bare Arch
RA-ARCH-PWDR	Product Arch Powder Charge
RA-UNI-12	12" Powder Coated Unistrut
RA-UNI-18	18" Powder Coated Unistrut
RA-SEC-FLASH	Flashing Section Upgrade
RA-PUCK-RGB	Lighted Pucks
RA-SPIN-LED	LED Spinner
RA-DOT-5K	LED DOT Light 5K

REACTION LIGHT STANDS

Material:	Aluminum cabinet with polycarbonate face
Mounting:	48" tall (2" bx 2") aluminum pedestal with 4" x 6" (1/2"h) baseplate OR wall mount
Power:	24 volt power supply included

Product #	Dimensions & Description
RL-1-FLOOR	19.5" W x 30.9" H. Water Drop Light, Pedestal Floor Mount, Powder Coated & Flasher
RL-1-WALL	19.5" W x 30.9" H Water Drop Light, Wall Mount, Powder Coated & Flasher
RL-2-FLOOR	20" w x 23.8" h. Shield 1 Light, Pedestal Floor Mount, Powder Coated & Flasher
RL-2-WALL	20" w x 23.8" h. Shield 1 Light, Wall Mount, Powder Coated & Flasher
RL-3-FLOOR	20" w x 20" h. Round Light, Pedestal Floor Mount, Powder Coated & Flasher
RL-3-WALL	20" w x 20" h. Round Light, Wall Mount, Powder Coated & Flasher
RL-4-FLOOR	19.9" w x 24" h. Shield 2 Light, Pedestal Floor Mount, Powder Coated & Flasher
RL-4-WALL	19.9" w x 24" h. Shield 2 Light, Wall Mount, Powder Coated & Flasher
RL-CUSTOM-GR	Custom Reaction Light Stand Graphics
RL-CUSTOM-SH	Custom Reaction Light Stand Shape
RL-1555	Light Back Light Delete



RL-1-WALL



RL-2-FLOOR



RL-3-FLOOR

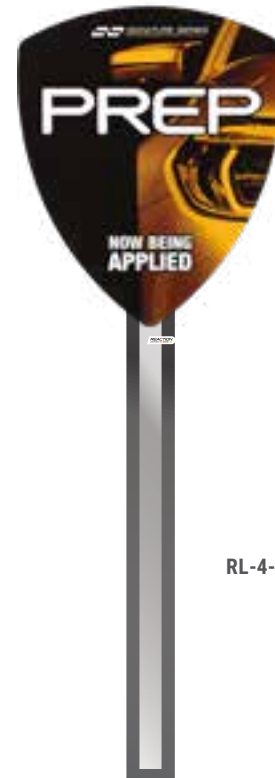

RL-4-FLOOR



Part #	Description
RPROJ-PROJECTOR	Customizable Projector Mounts to Middle of Arch
RPROJ-1COLOR	Quartz 1 Color Lens
RPROJ-2COLOR	Quartz 2 Color Lens
RPROJ-3COLOR	Quartz 3 Color Lens
RPROJ-4COLOR	Quartz 4 Color Lens



MOUNTABLE LEDS FOR REACTION ARCHES

Part #	Description
RLED-RGB-400	400 Watt RGB Led Light IP66 Rated.
RLED-RGB-300	300 Watt RGB Led Light IP66 Rated.
RLED-OCT	Octave Indoor/Outdoor Fixtures
RLED-OVER-WHT	Overture White 120v Standalone 8'
RLED-OVER-60	Overture 60 Watt RGB
RLED-OVER-80	Overture 80 Watt RGB
RLED-DUET	Duet Wall Lights
RLED-LYRIC-1014	Lyric Channel Letters 10-14"
RLED-LYRIC-1520	Lyric Channel Letters 15-20"

Part #	Description
RLED-LYRIC-2125	Lyric Channel Letters 21-25"
RLED-LYRIC-2630	Lyric Channel Letters 26-30"
RLED-CRESCENDO	Crescendo 6' RGB 300 Watt
RLED-CHORD	Chord 16.4' (each 80' requires power supply sold seperately)
RLED-HARMONY	Harmony Light Show Controller (required for all but Overture White)
RLED-SYNAPSE	Synapse Motor Controller Allows Color Change to White
RLED-MANAGE	Remote Management Fee For Light Show



REACTION

FOAMERS

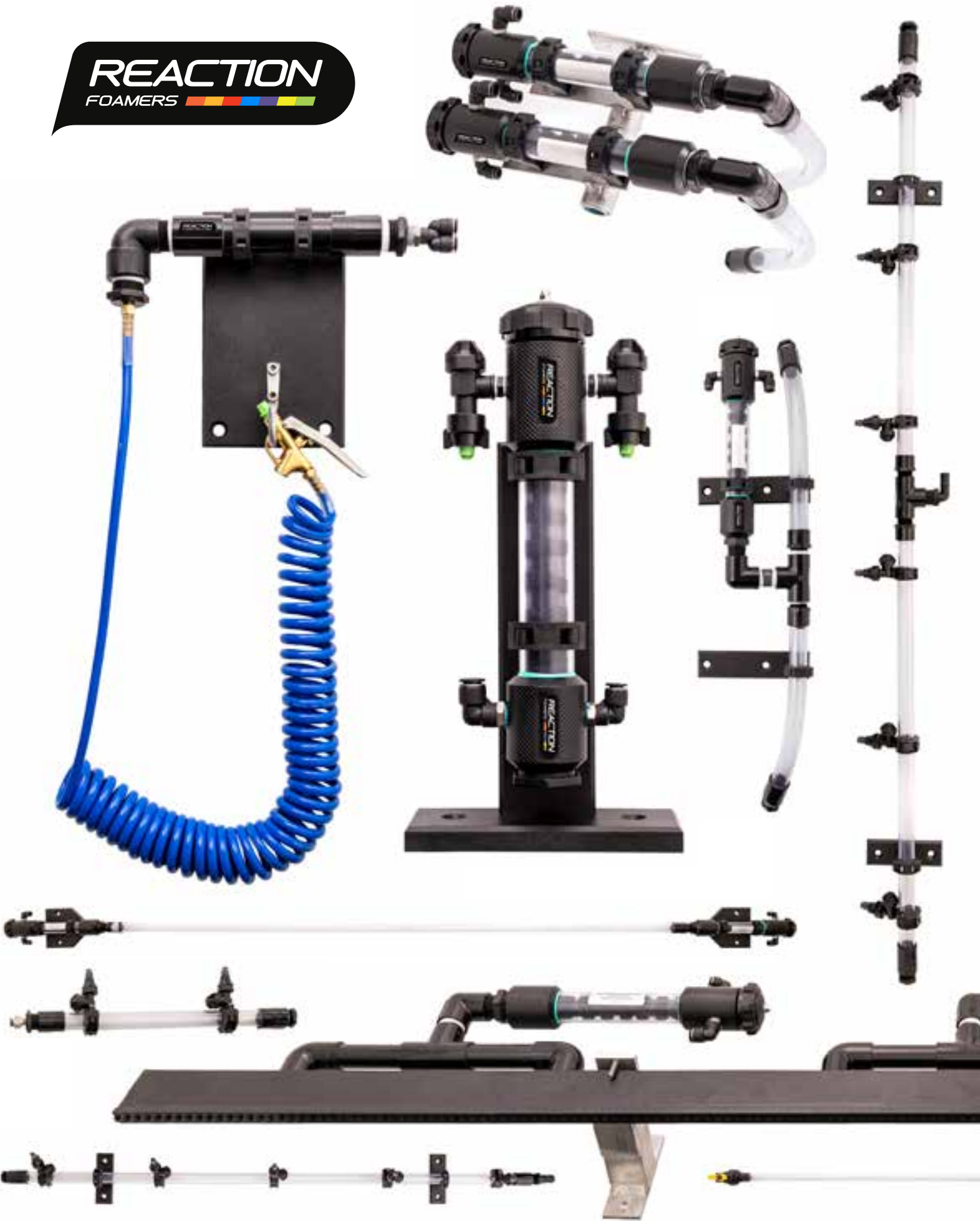

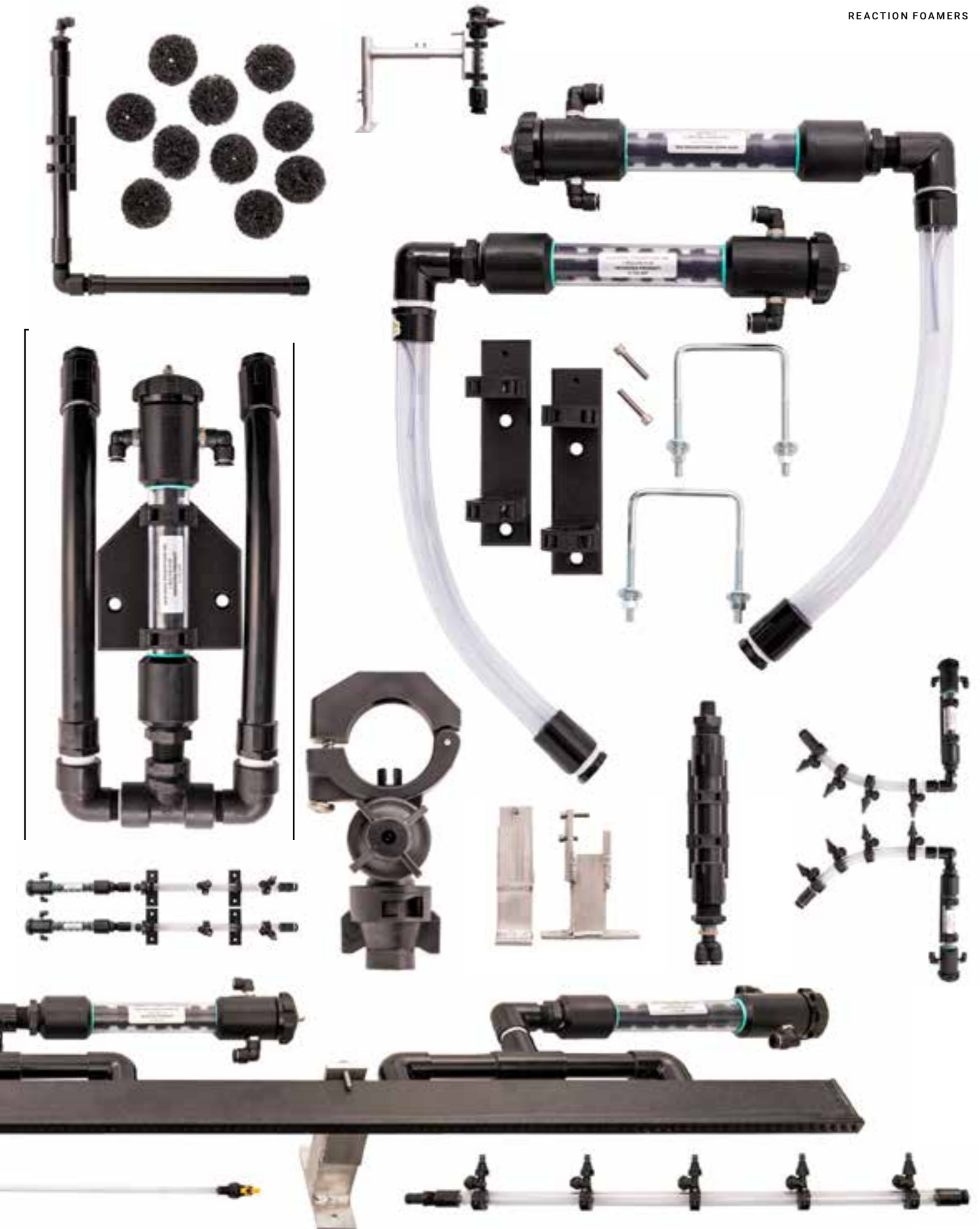

CALL FOR LATEST PRICING (816) 890-8995



Part #	Description
RF-1000	1-3 Color Rain Foamer with Mount
RF-1010	1-6 Color Rain Foamer W/Mount
RF-1060	1-3 Color Sheet Foamer W/Mount
RF-1070	1-6 Color Sheet Foamer W/Mount
RF-1080	1-3 Water Fall Sheet Applicator W/Mount
RF-1085	1-6 Water Fall Sheet Applicator W/Mount



Part #	RF-1030
Description	Rain/Sheet Foamer Standard Mount



Part #	RF-1040
Description	Extended Mount for Foamer and/or Light



Part #	RF-1050
Description	Extended Mount for 1-2 Foamer and/or Light



Part #	RF-3000
Description	Mega Top Foamer- 2 Generator with Mount



Part #	Description
RF-5000	Single Row Top Rinse Bar with Proportioning Valves with Mount
RF-6000	3 Row Top Rinse Bar with Proportioning Valves with Mount



Part #	RF-1090
Description	Premium Finishing Product Applicator with Wings with Mount



Part #	RF-3010
Description	Curved Top Foaming Applicator with Mount



Part #	RF-7000
Description	Single Floor Mount Foaming Bug/Pre-soak Applicator with Mount



Part #	RF-7010
Description	Two Floor Mount Foaming Bug/Pre-soak Applicator with Mount



Part # RF-5030

Description Adjustable Rinse Bar With Mount - Passenger Side



Part # RF-5040

Description Adjustable Rinse Bar With Mount - Driver Side



Part # RF-5050

Description Adjustable Rinse Arch - Top With Mount



Part # RF-5010

Description Set of 2 Mirror Rinse With Machined Holes and Mounts



Part # RF-5020

Description Set of 2 Mirror Rinse With Nozzles, Check Valves and Mounts



Part # RF-12010

Description Elephant Ear Foamer - 1 Side



Part # RF-12020
Description Elephant Ear Foamer - 1 Side with Mount



Part # RF-12030
Description Elephant Ear Foamer - Set of 2 with Mount



Part # RF-12040
Description Elephant Ear Foamer Mount Only



Part # RF-12060
Description Top Ear Foamer with Mount



Part # RF-12080
Description Twin Ear Foamer Single with Mount



Part # RF-12070
Description 2 Elephant Ear Sets with Top Ear Foamer - Includes Generators & Mounts



Part # RF-12090
Description Twin Ear Foamer Set with Mount



Part #	RF-12120
Description	Double Elephant Ear Set on One Mount - One Side



Part #	RF-12130
Description	Double Elephant Ear Set on One Mount - DS & PS



Part #	RF-12140
Description	Triple Elephant Ear Set on One Mount - One Side



Part #	RF-12150
Description	Triple Elephant Ear Set on One Mount - DS & PS



Part #	RF-12190
Description	Quad Elephant Ear Set on One Mount - One Side



Part #	RF-12200
Description	Quad Elephant Ear Set on One Mount -DS & PS





Part # RF-12220
Description Double Coat Set - 2 Each Side And 2 Top



Part # RF-7030
Description V-Jet Elephant Ear Set with Mounts



Part # RF-3040
Description Top Stick with Generator & Mount



Part # RF-3080
Description Foam Sticks with Generator & Mount



Part # RF-3090
Description 2 Sets of Foam Stick with Generator & Mount



Part #	Description
RF-3110	Triple Foam Sticks with Generator & Mounts
RF-3120	Triple Foam Sticks with Two (2) Sets of Generators & Mounts

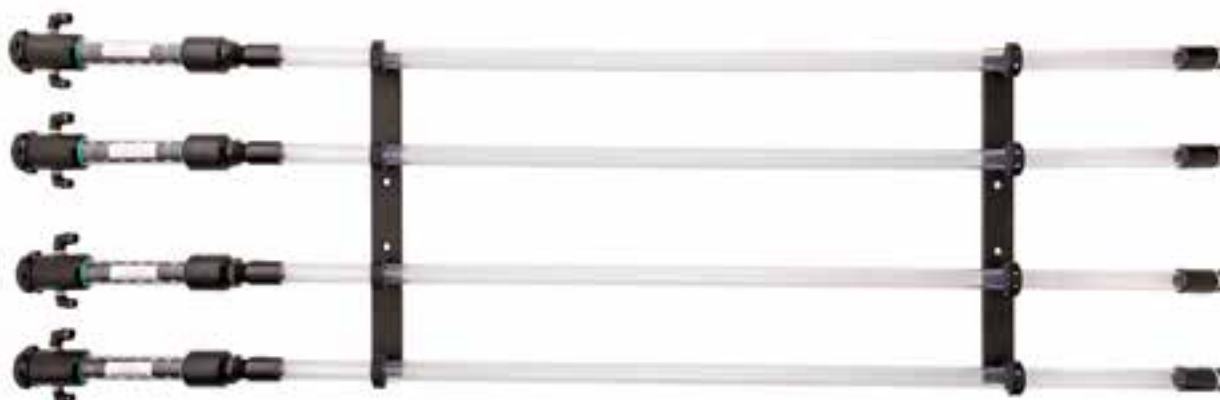

Part #	RF-3130
Description	Set of 2 Quad Foam Sticks with Generator & Mounts



Part #	RF-3150
Description	K-Foamer Side Stick with Mounting Kit



Part #	RF-3160
Description	Set of 2 K-Foamer Side Stick with Mounting Kit



Part #	RF-3170
Description	Horizontal K Stick with Mount



Part #	RF-7020
Description	Foaming Pre-soak Set - 2 Foam Sticks & Top Stick with Generators & Mounts



Part # RF-3220
Description Mini Generator



Part # RF-3240
Description Mini K Nozzle Generator with Mount



Part # RF-3250
Description Set of Mini K Nozzle Generators with Mounts



Part # RF-20000
Description CTA Applicator Single Unit



Part # RF-20002
Description CTA Applicator Single Unit with Mount



Part # RF-20004
Description Set of CTA Applicators with Mounts



Part # RF-20006
Description CTA Mounting Kit



Part # RF-20008
Description CTA Swivel Mounting Kit



Part # RF-20010
Description Applicator with Upgraded full cone Nozzles



Part # RF-20012
Description Applicator with Upgraded full cone Nozzles & Mount



Part # RF-20014
Description Set of Applicators with Upgraded full cone Nozzles & Mounts



Part # RF-3260
Description Mini Scent Generator with Mount



Part # RF-3190
Description Bug Juice Applicator with Mount



Part # RF-3200
Description Set of Bug Juice Applicators with Mounts



Part # RF-21050
Description Water Applicator with 2 Check Valve Body Nozzles



Part # RF-21052
Description Water Applicator with 3 Check Valve Body Nozzles



Part #	RF-21054
Description	Water Applicator with 4 Check Valve Body Nozzles



Part #	RF-21056
Description	Water Applicator with 5 Check Valve Body Nozzles



Part #	RF-20020
Description	Tire & Wheel Rinse Applicator without Mount



Part #	RF-20022
Description	Tire & Wheel Rinse Applicator with Mount



Part #	RF-20024
Description	Set of Tire & Wheel Rinse Applicators with Mounts

PARTS WITHOUT PICTURES

Part #	Description
RF-5090	Top Manifold with 6 Nozzles
RF-3030	Top Stick with Generator
RF-0010	Easy Clean Generator
RF-0012	Replacement Generator Body
RF-0014	Replacement Generator Cap
RF-0016	Replacement Generator Insert
RF-0018	Replacement Generator Pad
RF-0020	Replacement Generator Ball



SCUBA TANKS, BRACKETS, & LIDS



Part #	SC-9008
Description	SCUBA Tank 8 G Assembled. Used with 2.5 GAL bottles



Part #	SC-9015
Description	SCUBA Tank 15 G Assembled. Used with 2.5 GAL bottles.



Part #	SC-9007
Description	SCUBA Tank 7 G Assembled. Used with 1 Gallon Bottles.

PICTURE NOT AVAILABLE

Part #	SC-1024
Description	SCUBA Wall Bracket



Part #	SC-6000
Description	SCUBA Lid for both 8 and 15 G SCUBA

SCUBA SPEARS

1 GALLON



5 GALLON



7 GALLON



8 GALLON



16 GALLON



Part #	Description
SC-8001	1 Gallon Spear
SC-8005	5 Gallon Spear
SC-8007	7 Gallon Spear
SC-8008	8 Gallon Spear
SC-8015	15 Gallon Spear

TITRATION EQUIPMENT

Part #	Description
TK-1000	Customer Titration Kit
TK-1200	Distributor Titration Kit
TK-7100	Titration Solution - Alkaline 0.5N HCl
TK-7000	Titration Solution - Acidity 0.5N NaOH
TK-8300	Titration Solution - Indicator
TK-10825	Titration Sample Bottle
TK-4002	Distributor Titration Container
TK-7200	Titration Solution-Alkaline 5.0 ON HCl
TK-10825	Titration Bottle



Part #	TK-2000
Description	Chlorine Test Kit



Part #	TK-3900
Description	PH Test Strips 0-14



Part #	TK-8000
Description	Soft Water Test Kit



Part #	TK-8100
Description	TDS Tester



Part #	TK-99009
Description	Chemical Bay Sample Bottle



Part #	TK-4001
Description	Pipette

TUBING

**PICTURE
NOT
AVAILABLE**

Part #	TB-1000
Description	PVC Tubing. 100' Roll of 3/8" o.d x 1/4" i.d. Tubing

**PICTURE
NOT
AVAILABLE**

Part #	TB-3000
Description	100' Roll of 3/8" o.d x 1/4" i.d. Chemical Resistant Tubing

TIPS



Part # 1001290
Description Spiral Metering Tip



Part # MT-100-15K-EX4
Description Dema Screw in Tip Kit with 4 new Tips



Part # MT-90031210
Description Push In Ultra Lean Tip Kit



Part # MT-100-15KU
Description Dema Screw In Ultra Lean Tip Kit



Part # MT-690014
Description Push In Tip Kit





















Part # MT-100-15K
Description Dema Screw in Tip Kit



	Part #	Description
	MT-100.15.14	Dema Screw in Copper (610:1)
	MT-100.15.	Dema Screw in Pumpkin (504:1)
	MT-100.15.16	Dema Screw in Burgundy (425:1)
	MT-100.15.17	Dema Screw in Lime Green (389:1)
	MT-100.15.0	Dema Screw in Tan Tip (366:1)
	MT-100.15.1	Dema Screw in Org. Tip (256:1)
	MT-100.15.2	Dema Screw in Turq. Tip (183:1)
	MT-100.15.19	Dema Screw in Royal Blue Tip (173:1)
	MT-100.15.20	Dema Screw in Charcoal Gray Tip (155:1)
	MT-100.15.3	Dema Screw in Pink Tip (128:1)
	MT-100.15.23	Dema Screw in Dark Green Tip (112:1)
	MT-100.15.4	Dema Screw in Lt. Blue Tip (102:1)
	MT-100.15.5	Dema Screw in Brown Tip (91:1)
	MT-100.15.6	Dema Screw in Red Tip (73:1)
	MT-100.15.7	Dema Screw in White Tip (58:1)
	MT-100.15.8	Dema Screw in Green Tip (51:1)
	MT-100.15.9	Dema Screw in Blue Tip (41:1)
	MT-100.15.21	Dema Screw in Light Purple Tip (35:1)
	MT-100.15.10	Dema Screw in Yellow Tip (27:1)
	MT-100.15.11	Dema Screw in Black Tip (22:1)
	MT-100.15.BU1	Dema Screw in Light Org Tip (18:1)
	MT-100.15.12	Dema Screw in Purple Tip (15:1)
	MT-100.15.18	Dema Screw in Gray Tip (13:1)

TIPS



















	Part #	Description
	MT-690002	Push in Tip Pink (240:1)
	MT-10067610	Push in Tip Tiny Hole Black (210:1)
	MT-690026	Push in Tip Light Gray (180:1)
	MT-690003	Push in Tip Purple (120:1)
	MT-10067611	Push in Tip Red (Darker (115:1)
	MT-690016	Push in Tip Aqua (100:1)
	MT-690004	Push in Tip Yellow (90:1)
	MT-690068	Push in Tip Dark Blue (83:1)
	MT-690005	Push in Tip Brown (75:1)
	MT-690024	Push in Tip Orange (64:1)
	MT-690006	Push in Tip Green (48:1)
PICTURE NOT AVAILABLE	MT-690031	Push in Tip Light Blue (39:1)
	MT-690007	Push in Tip Tan (36:1)
	MT-690008	Push in Tip Blue (25:1)
	MT-690025	Push in Tip White (23:1)
	MT-690009	Push in Tip Red (17:1)
	MT-690010	Push in Tip Beige (8:1)
	MT-690011	Push in Tip Black (6:1)
	MT_60012	Push in Tip Gray (5:1)



**NPT X NPT SINGLE
HOSE BARB**



**NPT X NPT DUAL
HOSE BARB**

COLOR	Flow Rate @ 200 PSI (14 bar)	SINGLE BARB PART NUMBER	DUAL BARB PART NUMBER
Red	1.00 GPM (3.8 LPM)	 IN-118057	 IN-129057
Orange	1.50 GPM (5.7 LPM)	 IN-118070	 IN-129070
Gray	2.00 GPM (7.6 LPM)	 IN-118083	 IN-129083
Dark Blue	2.25 GPM (8.5 LPM)	 IN-118086	 IN-129086
Light Blue	3.00 GPM (11.3 LPM)	 IN-118098	 IN-129087
Light Green	3.25 GPM (12.3 LPM)	 IN-118096	 IN-129098
Pink	3.75 GPM (14.2 LPM)	 IN-118107	 IN-129106
Purple	4.50 GPM (17.0 LPM)	 IN-118117	 IN-129117
Dark Green	5.50 GPM (20.8 LPM)	 IN-118125	 IN-129125



**PC1 ALL COMPOSITE
SINGLE HOSE BARB**



**PC1 ALL COMPOSITE
DUAL HOSE BARB**





COLOR	Flow Rate @ 200 PSI (13.9 bar)	SINGLE BARB PART NUMBER	DUAL BARB PART NUMBER
White	0.25 GPM (1.0 LPM)	 IN-318029	-
Yellow	0.50 GPM (1.9 LPM)	 IN-318040	 IN-329040
Tan	0.75 GPM (2.8 LPM)	 IN-318051	 IN-329051
Red	1.00 GPM (3.8 LPM)	 IN-318057	 IN-329057
Orange	1.50 GPM (5.7 LPM)	 IN-318070	 IN-329070
Gray	2.00 GPM (7.6 LPM)	 IN-318083	 IN-329083
Dark Blue	2.25 GPM (8.5 LPM)	 IN-318086	 IN-329086
Light Blue	3.00 GPM (11.3 LPM)	 IN-318095	 IN-329095
Light Green	3.25 GPM (12.3 LPM)	 IN-318098	 IN-329098
Pink	3.75 GPM (14.2 LPM)	 IN-318106	 IN-329106
Purple	4.50 GPM (17.0 LPM)	-	-
Dark Green	5.50 GPM (20.8 LPM)	 IN-318125	 IN-329107

PC2 ALL COMPOSITE INJECTORS



PC2 ALL COMPOSITE SINGLE HOSE BARB

PC2 ALL COMPOSITE DUAL HOSE BARB

COLOR	Flow Rate @ 200 PSI (13.9 bar)	SINGLE BARB PART NUMBER	DUAL BARB PART NUMBER
White	0.25 GPM (1.0 LPM)	 IN-718029	 IN-729029
Yellow	0.50 GPM (1.9 LPM)	 IN-718040	 IN-729040
Tan	0.75 GPM (2.8 LPM)	 IN-718051	 IN-729051
Red	1.00 GPM (3.8 LPM)	 IN-718057	 IN-729057
Orange	1.50 GPM (5.7 LPM)	 IN-718070	 IN-729070
Gray	2.00 GPM (7.6 LPM)	 IN-718083	 IN-729083
Dark Blue	2.25 GPM (8.5 LPM)	 IN-718087	 IN-729087
Light Blue	3.00 GPM (11.3 LPM)	 IN-718095	 IN-729095
Light Green	3.25 GPM (12.3 LPM)	 IN-718098	 IN-729098
Pink	3.75 GPM (14.2 LPM)	 IN-718106	 IN-729106
Purple	4.50 GPM (17.0 LPM)	 IN-718117	 IN-729117
Dark Green	5.50 GPM (20.8 LPM)	 IN-718125	 IN-729125

PC1 VERSADIAL™ INJECTORS



**PC1 VERSADIAL™
SINGLE HOSE BARB**



**PC1 VERSADIAL™
DUAL HOSE BARB**







COLOR	Flow Rate @ 200 PSI (13.9 bar)	SINGLE BARB PART NUMBER	DUAL BARB PART NUMBER
White	0.25 GPM (1.0 LPM)	 IN-317029	-
Yellow	0.50 GPM (1.9 LPM)	 IN-317040	 IN-327040
Tan	0.75 GPM (2.8 LPM)	 IN-317051	 IN-327051
Red	1.00 GPM (3.8 LPM)	 IN-317057	 IN-327057
Orange	1.50 GPM (5.7 LPM)	 IN-317070	 IN-327070
Gray	2.00 GPM (7.6 LPM)	 IN-317083	 IN-327083
Dark Blue	2.25 GPM (8.5 LPM)	 IN-317086	 IN-327086
Light Blue	3.00 GPM (11.3 LPM)	 IN-317095	 IN-327095
Light Green	3.25 GPM (12.3 LPM)	 IN-317098	 IN-327098
Pink	3.75 GPM (14.2 LPM)	 IN-317106	 IN-327106
Purple	4.50 GPM (17.0 LPM)	-	-
Dark Green	5.50 GPM (20.8 LPM)	 IN-317125	 IN-327125



**PC2 VERSADIAL™
SINGLE HOSE BARB**



**PC2 VERSADIAL™
DUAL HOSE BARB**

COLOR	Flow Rate @ 200 PSI (13.9 bar)	SINGLE BARB PART NUMBER	DUAL BARB PART NUMBER
White	0.25 GPM (1.0 LPM)	 IN-717029	 IN-727029
Yellow	0.50 GPM (1.9 LPM)	 IN-717040	 IN-727040
Tan	0.75 GPM (2.8 LPM)	 IN-717051	 IN-727051
Red	1.00 GPM (3.8 LPM)	 IN-717057	 IN-727057
Orange	1.50 GPM (5.7 LPM)	 IN-717070	 IN-727070
Gray	2.00 GPM (7.6 LPM)	 IN-717083	 IN-727083
Dark Blue	2.25 GPM (8.5 LPM)	 IN-717086	 IN-727086
Light Blue	3.00 GPM (11.3 LPM)	 IN-717095	 IN-727095
Light Green	3.25 GPM (12.3 LPM)	 IN-717098	 IN-727098
Pink	3.75 GPM (14.2 LPM)	 IN-717106	 IN-727106
Purple	4.50 GPM (17.0 LPM)	 IN-717117	 IN-727117
Dark Green	5.50 GPM (20.8 LPM)	 IN-717125	 IN-327125

PC3 QUICK-CONNECT INJECTORS



**PC3 ALL COMPOSITE
QUICK CONNECT HOSE BARB**

COLOR	Flow Rate @ 200 PSI (13.9 bar)	PC3 INJECTOR PART NUMBER
Black	8.00 GPM (30.3 LPM)	IN-818161
Black	10.00 GPM (37.9 LPM)	IN-818177
Black	12.00 GPM (45.2 LPM)	IN-818186
Black	15.00 GPM (56.8 LPM)	IN-818207



**PC3 VERSADIAL™
QUICK CONNECT HOSE BARB**

COLOR	Flow Rate @ 200 PSI (13.9 bar)	PC3 INJECTOR PART NUMBER
Black	8.00 GPM (30.3 LPM)	IN-817161
Black	10.00 GPM (37.9 LPM)	IN-817177
Black	12.00 GPM (45.2 LPM)	IN-817186
Black	15.00 GPM (56.8 LPM)	IN-817207



Part # IN-618040
Description HYDRA-FLEX .040



Part # IN-618051
Description HYDRA-FLEX .051



Part # IN-618057
Description HYDRA-FLEX .057



Part # IN-618070
Description HYDRA-FLEX .070



Part # IN-618083
Description HYDRA-FLEX .083



Part # IN-618086
Description HYDRA-FLEX .086



Part # IN-618098
Description HYDRA-FLEX .098



Part # IN-618125
Description HYDRA-FLEX .125



Part # IN-629083
Description HYDRA-FLEX Dual .083



Part # IN-629125
Description HYDRA-FLEX Dual .125



Part # IN-929083
Description Injector .083 HDPE 2 Barb NPT x NPT



Part # IN-100336RD
Description General .057 Injector 1 Barb - Kynar. With 0.057" Orifice - 1.0 GPM



Part # IN-100334GY
Description General .083 Injector 1 Barb - Kynar. With 0.083" Orifice - 2.0 GPM



Part # IN-100541GY
Description General .083 Injector 2 Barb - Kynar. With 0.083" Orifice - 2.0 GPM



Part # IN-100333BL
Description General .086 Injector 1 Barb - Kynar. With 0.086" Orifice - 2.3 GPM



Part # IN-100339LG
Description General .098 Injector 1 Barb - Kynar. With 0.098" Orifice - 3.25 GPM



Part # IN-101010DG
Description General .125 Injector 1 Barb - Kynar. With 0.125" Orifice - 5.5 GPM



Part # IN-101033
Description General .041 Injector 1 Barb - Kynar Quick Con. With 0.041" Orifice - 0.5gpm



Part # IN-101034
Description General .041 Injector 2 Barb - Kynar Quick Con. With 0.041" Orifice - 0.5gpm



Part # IN-101035
Description General .041 Injector 3 Barb - Kynar Quick Con. With 0.041" Orifice - 0.5gpm



Part # IN-101073
Description General .051 Injector 1 Barb - Kynar Quick Con. With 0.051" Orifice - 0.75gpm



Part # IN-101075
Description General .051 Injector 2 Barb - Kynar Quick Con. With 0.051" Orifice - 0.75gpm



Part # IN-101074
Description General .051 Injector 3 Barb - Kynar Quick Con. With 0.051" Orifice - 0.75gpm



Part # IN-101030
Description General .057 Injector 1 Barb - Kynar Quick Con. With 0.057" Orifice - 1.0 GPM



Part # IN-101031
Description General .057 Injector 2 Barb - Kynar Quick Con. With 0.057" Orifice - 1.0 GPM



Part # IN-101032
Description General .057 Injector 3 Barb - Kynar Quick Con. With 0.057" Orifice - 1.0 GPM



Part # IN-101027
Description General .070 Injector 1 Barb - Kynar Quick Con. With 0.070" Orifice - 1.4 GPM

INJECTORS



Part # IN-101028
Description General .070 Injector 2 Barb - Kynar Quick Con. With 0.070" Orifice - 1.4 GPM



Part # IN-101029
Description General .070 Injector 3 Barb - Kynar Quick Con. With 0.070" Orifice - 1.4 GPM



Part # IN-101024
Description General .083 Injector 1 Barb - Kynar Quick Con. With 0.083" Orifice - 2.1 GPM



Part # IN-101025
Description General .083 Injector 2 Barb - Kynar Quick Con. With 0.083" Orifice - 2.1 GPM



Part # IN-101026
Description General .083 Injector 3 Barb - Kynar Quick Con. With 0.083" Orifice - 2.1 GPM



Part # IN-101021
Description General .086 Injector 1 Barb - Kynar Quick Con. With 0.083" Orifice - 2.3 GPM



Part # IN-101022
Description General .086 Injector 2 Barb - Kynar Quick Con. With 0.083" Orifice - 2.3 GPM



Part # IN-101023
Description General .086 Injector 3 Barb - Kynar Quick Con. With 0.083" Orifice - 2.3 GPM



Part # IN-101019
Description General .098 Injector 2 Barb - Kynar Quick Con. With 0.098" Orifice - 3.2 GPM



Part # IN-101020
Description General .098 Injector 3 Barb - Kynar Quick Con. With 0.098" Orifice - 3.2 GPM



Part # IN-101037
Description General .125 Injector 1 Barb - Kynar Quick Con. With 0.125" Orifice - 5.5 GPM



Part # IN-101038
Description General .125 Injector 2 Barb - Kynar Quick Con. With 0.125" Orifice - 5.5 GPM



Part # IN-101072
Description General .125 Injector 3 Barb - Kynar Quick Con. With 0.125" Orifice - 5.5 GPM



Part #	IN-1002531
Description	Hydraflex Versadial Control Valve



Part #	PDQ11240002
Description	G5 Dual Injector



Part #	PDQ11240001
Description	G5 .086 Single Injector

INJECTOR PARTS WITHOUT PICTURES

Part #	Description
IN-1002997	HYDRA-FLEX PC1 Flow Thru 4 GPM
IN-1002998	HYDRA-FLEX PC1 Flow Thru 8 GPM
IN-1002999	HYDRA-FLEX PC2 6 GPM Flow Through Rinse
IN-1003000	HYDRA-FLEX PC2 8 GPM Flow Through Rinse
IN-1003001	HYDRA-FLEX PC2 10 GPM Flow Through Rinse
IN-1003002	HYDRA-FLEX PC2 12 GPM Flow Through Rinse
IN-100094WT	General .062 Injector 1 Barb -Kynar. With 0.062" Orifice - 1.2 GPM
IN-1008350R	General .070 Injector 1 Barb -Kynar. With 0.070" Orifice - 1.5 GPM
IN-101018	General .098 Injector 1 Barb-Kynar Quick Con. With 0.098" Orifice - 3.2 GPM
01-421200-SS	MPT X QC Disconnect. 3/8" MPT x 3/8" Disconnect

MISCELLANEOUS CAR WASH PARTS



Part # 1001756
Description Hydraflex Check Hub Assy



Part # EDUCTOR-D-1/4
Description Dual Eductor Complete



Part # 00-6020L
Description Large Latex Gloves - Nitrishield



Part # USP064048
Description 1/4" In-line Check



Part # 5722990
Description Gray In-line Check Valve Barb X Barb



Part # 250021
Description Hydro Blue In-line Check Valve Barb X Barb



Part # 250020
Description Hydro Blue Foot valve



Part # 100-16V
Description Dema Foot valve



Part # 100.11.PVC
Description Foot valve For Spear



Part # 5057-A
Description Hydrominder Distribution Tube



Part # 6655K
Description Hydrominder Repair Kit



Part # 491311
Description 1/4" Check Valve Barb



Part # 3401-R
Description 1/4" mpt x 1/4" hb for Push In Hydrominder Tip



Part # 64374
Description 1/4" MPT x HB Plastic



Part # 64346
Description 1/4" HB Tee



Part # 62232
Description 1/4" HB Y Splice



Part # 33093B
Description 1/4" HB Splice Black Plastic



Part # 1001290
Description 1/2" HB Splice Black Plastic



Part # 257379
Description 1/4" St. Elbow Black Plastic



Part # 64888
Description 1/4" FPT x 3/4" MGH White Plastic



Part # 00-402CPV01
Description Diaphragm Check Valve M x F



Part # 00-402CPV02
Description Diaphragm Check Valve M x F (Cap)



Part # 00-20399.7
Description K Nozzle Adapter



Part # 00-20399.8
Description Cap For Quick Attach K Nozzle



Part # 00-20399.4
Description Gasket



Part # 4200-0004E
Description Diaphragm For Check Valve



Part # 00-20399.6
Description Black K Nozzle - Hydro Deflectip 10 Black 2 GPM



Part #	00-20399.5
Description	Pink K Nozzle - Hypro Deflectip 15 Pink 3 GPM



Part #	00-20399.11
Description	Blue K Nozzle - Hypro Deflectip 1.5 Blue 0.30 GPM

MISCELLANEOUS PARTS WITHOUT PICTURES

Part #	Description
CT3000	Digital Scale 60lb capacity
250100	Hydro Gray Foot valve
64281	1/4" x 1/2" Hose Splice
33093B	1/4" Hose Splice plastic
1001290	1/2" Hose Splice plastic
30150R	Garden Hose Washer. O-ring, Garden Hose 3/4" Red
64716	1/4" Plug
00-20399.5	Orange K Nozzle - Hypro Deflectip 0.5 Orange 0.10 GPM
00-20399.9	Green K Nozzle - Hypro Deflectip 0.75 Green 0.15 GPM
CW-STARTUP	Car Wash Start Up Kit
L-20025H-100	100mL Graduated Cylinder
L-2BE-12592	1000mL Graduated Cylinder

Part #	Description
3427	Wrench for 5 gallon squares
DRUMWRENCH	Bung Wrench
SC-100100	2 Level Scuba Rack - Single Sided - Aluminum Finish
SC-100105	Extension for 2 Level Scuba Rack - Single Sided - Aluminum Finish
SC-100500	1 Level Scuba Rack - Single Sided - Aluminum Finish
SC-100505	Extension for 1 Level Scuba Rack - Single Sided - Aluminum Finish
SC-101000	Mobile Scuba Rack - 2 sided 2 Levels - Aluminum Finish



NATIONAL CAR WASH PARTS

Signature Series Professional Car Wash Products are
Manufactured in the United States by C K Enterprises, Inc.

C K Enterprises, Inc.
1992 NW HWY 50
Lone Jack, MO 64070

Tel: (816) 524-1304
Fax: (816) 524-3260
Web: ckcarcare.com



SCAN FOR DIGITAL CATALOG



C K Enterprises Inc.

REV-072623